

HIGH PRESSURE VALVES, FITTINGS AND TUBING

BuTech High Pressure Valves are designed for liquid and gas flow control in petroleum, chemical, power generating and general industrial applications.

Available in a variety of body styles, the valves are designed for operation at temperatures ranging from -100° to +600°F (-73° to +315°C). Optional packings and/or extended stuffing boxes increase the range to -423° to +1200°F (-253° to +648°C).

Their rugged construction provides assurance of fail-safe operation at pressures ranging to 150,000 PSI (10,340 bar).

Needle Valve Features:

- Non-rotating stem prevents galling and scoring
- Four stem styles:
 - Vee
 - Metering
 - Regulating
 - Micro-Metering
- 17-4PH Stem for longer service life. 316 wetted parts are also available by specifying option **-316WP** (see page HP-3)
- Glass-filled packing for temperatures to 600°F (315°C)
- Integral through holes for bracket mounting, a panel-mounting option is also available (see page HP-3)
- Wide range of options allow customizing of valve
- Positive gland locking device

Materials of Construction

Standard materials of construction include 316 cold-worked stainless steel, 17-4PH, and glass-filled teflon. All BuTech equipment may also be produced in any machinable metal. Some of the more common exotic materials used are:

- Hastelloy™
- Inconel™
- Titanium
- Monel 400™

Tube Sizes: 1/4" through 1"
Pressures to 150,000 PSI (10,340 bar)
Type: H/P Cone-and-Thread

Tube O.D.	Connection	Orifice	Cv*	MAWP+
1/4"	1/4" H/P	0.093" (2.4)	0.12	30,000 PSI 2070 bar
3/8"	3/8" H/P	0.125" (3.2)	0.23	30,000 PSI 2070 bar
9/16"	9/16" H/P	0.187" (4.7)	0.33	30,000 PSI 2070 bar
1"	1" H/P	0.438" (11.1)	2.80	30,000 PSI 2070 bar
9/16"	9/16" H/P	0.109" (2.8)	0.31	40,000 PSI 2760 bar
1/4"	1/4" H/P	0.062" (1.6)	0.08	60,000 PSI 4140 bar
3/8"	3/8" H/P	0.062" (1.6)	0.09	60,000 PSI 4140 bar
9/16"	9/16" H/P	0.078" (2.0)	0.14	60,000 PSI 4140 bar
5/16"	5/16" H/P	0.094" (2.4)	0.08	150,000 PSI 10340 bar

*Cv values listed are for 2-way straight pattern valves excluding metering valves.

For 2-way angle pattern valves, increase Cv value by 50%.

For Metering Valves: Cv=.004, Port size=0.062" (1.57 mm)

+Maximum allowable working pressure at 72° F (22° C)

Equipment	Page
150,000 PSI Equipment	HP-19
Anti-Vibration Glands	HP-15
Bulkhead Couplings	HP-13
Caps	HP-15
Check Valves	HP-16
Collars	HP-15
Couplings	HP-13
Crosses	HP-12
Elbows	HP-12
Filters	HP-17
Glands	HP-15
Metering and Needle Valves, 30,000 PSI	HP-4
Metering and Needle Valves, 60,000 PSI	HP-9
Needle Valves, 40,000 PSI	HP-8
Nipples	HP-14
Options	HP-3
Plugs	HP-15
Safety Heads	HP-18
Tees	HP-12
Tubing	HP-14

Collars and Glands included with all valves and fittings

All dimensions are for reference only and are subject to change.
 Dimensions in parentheses are millimeters (mm)



ORDERING INFORMATION & REPLACEMENT PARTS

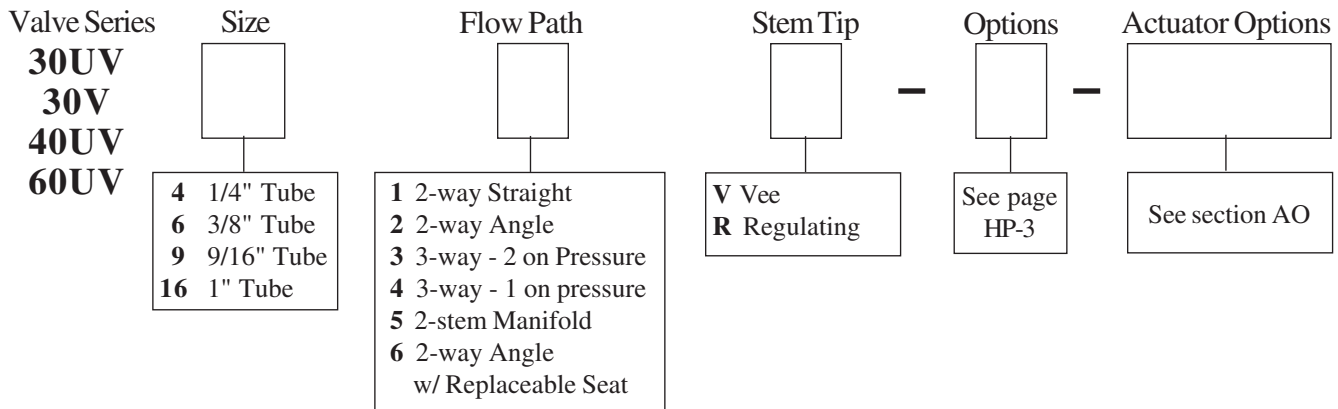

Examples:

30UV42V specifies a 2-way angle valve for 1/4" tube with a Vee stem

60UV91R-PM specifies a 2-way straight valve for 9/16" tube with regulating stem and panel-mount packing gland option

Replacement Parts

BuTech offers replacement parts in a variety of packages so you can purchase just the parts you need.

Replacement Stem Kit contains just the stem

Replacement Packing Kit contains all soft packing rings

Repair Kits contain stem, stem sleeve, stem nuts and washers, packings and packing washers (replacement seat where applicable)

Valve Series	Repair Kits		Replacement Stem	Replacement Packings	Replacement Valve Body
	All others	Replaceable Seat			
30UV4	RK-30UV4*	RK-30UV46*	30S4*	30PK4*	30UV4+
30UV6	RK-30UV6*	RK-30UV66*	30S6*	30PK6*	30UV6+
30UV9	RK-30UV9*	RK-30UV96*	30S9*	30PK9*	30UV9+
30V16	RK-30V16*	RK-30V166*	30S16*	30PK16*	30V16+
40UV9	RK-40UV*	RK-40UV96*	40S9*	40PK9*	40UV9+
60UV4	RK-60UV4*	RK-60UV46*	60S4*	60PK4*	60UV4+
60UV6	RK-60UV6*	RK-60UV66*	60S6*	60PK6*	60UV6+
60UV9	RK-60UV9*	RK-60UV96*	60S9*	60PK9*	60UV9+

*Complete catalog number by adding the following:

V or **R** for stem type

Suffix for special packing materials (see page HP-3)
(ex. **-GR** for Grafoil packings)

Suffix for special materials
(ex. **-HC** for Hastelloy)

-LT or **-HT** for cryogenic or high-temperature service

-WAO for a valve fitted with an actuator

+Complete catalog number by adding the flow path designator:

- 1** 2-way straight
- 2** 2-way angle
- 3** 3-way, 2 connections on pressure
- 4** 3-way, 1 connection on pressure
- 5** 2-stem manifold
- 6** 2-way angle with replaceable seat

NEEDLE VALVE OPTIONS

Packing and Stem Materials

- GR Grafoil packings for service to 800°F (426°C)
- TFE Virgin Teflon packing for service to 450°F (232°C)
- 316WP 316 wetted parts
- STS Stellite tipped stem
- SRS Stellite replaceable seat (Replaceable seat valves only)

Handle Options

- PH Round plastic handle in place of aluminum (available on 1/4" through 9/16" sizes)
- SS Stainless steel handle in place of aluminum (available on 1/4" through 9/16" sizes, on 1" SS is standard)
- EXT_ Handle extended above valve body, specify number of inches of extra height desired (Ex: **EXT6** is a 6" extension)

Security Options

- HLD Handle locking device (prevents unauthorized opening/closing of valve)
- SLD Stem locking device (prevents stem from turning due to vibration)

Extreme Service

- AVG Anti-vibration glands instead of standard glands for applications with excessive vibration or shock
- O2 Cleaned for oxygen service
- SOG For Sour Gas service in accordance with NACE MR-01-75 (See Section OF for details)
- HT Extended stuffing box, graphite packing, and materials for high-temperature service to 1200°F (648°C)
- HTF Finned extended stuffing box, graphite packing, and materials for high-temperature service to 1200°F (648°C)
- LT Extended stuffing box, teflon packing, and materials for cryogenic service to -423°F (-251°C)
- LTF Finned extended stuffing box, teflon packing, and materials for cryogenic service to -423°F (-251°C)

Valve Model	A
30UV	6.14" (156.0)
30V	10.76" (273.3)
40UV	5.88" (149.4)
60UV	5.88" (149.4)

-HT or -LT Options

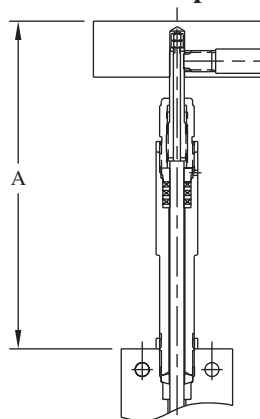

Cylindrical Bonnet

-HTF or -LTF Options

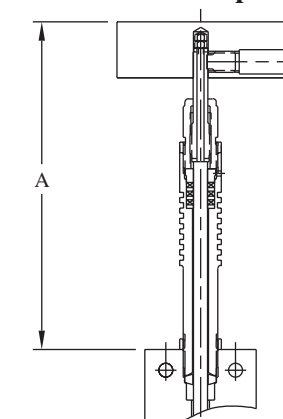

Finned Bonnet

Panel Mount

- PM Panel-mount packing gland

Valve Model	Panel Hole Size	Max Panel Thickness	H
30UV	0.84" (21.3)	0.37" (9.4)	0.48" (12.2)
30V	1.41" (35.8)	0.62" (15.7)	0.97" (24.6)
40UV	0.84" (21.3)	0.37" (9.4)	0.48" (12.2)
60UV	0.84" (21.3)	0.37" (9.4)	0.48" (12.2)

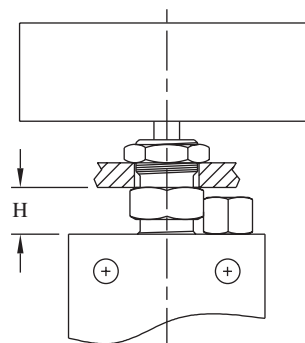

All dimensions are for reference only and are subject to change.
Dimensions in parentheses are millimeters (mm)

NEEDLE VALVES FOR 30,000 PSI (2070 BAR)

1/4" H/P TUBE, CONED AND THREADED

2-way Straight

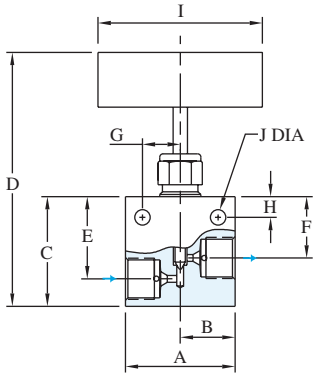

Figure 1

2-way Angle

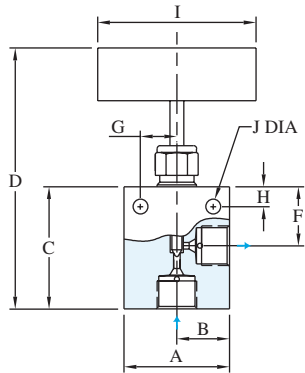

Figure 2

3-way Two on Pressure

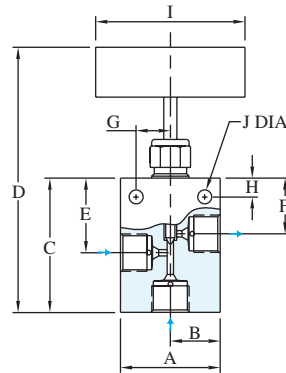

Figure 3

3-way One on Pressure

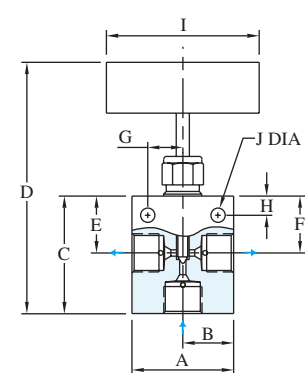

Figure 4

Catalog Number	Stem Style	Connection	A	B	C	D	E	F	G	H	I	J	K	L	Thk.	Fig
30UV41V	Vee	1/4" H/P	2.00"	1.00"	2.00"	4.75"	1.50"	1.12"	0.69"	0.38"	3.00"	0.28"	---	---	1.00"	1
30UV41R	Reg	Tube	(50.8)	(25.4)	(50.8)	(120.7)	(38.1)	(28.4)	(17.5)	(9.7)	(76.2)	(7.1)	---	---	(25.4)	
30UV42V	Vee	1/4" H/P	2.00"	1.00"	2.00"	4.75"	---	1.12"	0.69"	0.38"	3.00"	0.28"	---	---	1.00"	2
30UV42R	Reg	Tube	(50.8)	(25.4)	(50.8)	(120.7)	---	(28.4)	(17.5)	(9.7)	(76.2)	(7.1)	---	---	(25.4)	
30UV43V	Vee	1/4" H/P	2.00"	1.00"	2.12"	4.87"	1.50"	1.12"	0.69"	0.38"	3.00"	0.28"	---	---	1.00"	3
30UV43R	Reg	Tube	(50.8)	(25.4)	(53.8)	(123.7)	(38.1)	(28.4)	(17.5)	(9.7)	(76.2)	(7.1)	---	---	(25.4)	
30UV44V	Vee	1/4" H/P	2.00"	1.00"	2.00"	4.75"	1.12"	1.12"	0.69"	0.38"	3.00"	0.28"	---	---	1.00"	4
30UV44R	Reg	Tube	(50.8)	(25.4)	(50.8)	(120.7)	(28.4)	(28.4)	(17.5)	(9.7)	(76.2)	(7.1)	---	---	(25.4)	
30UV45V	Vee	1/4" H/P	2.00"	1.00"	3.06"	8.56"	1.53"	1.12"	0.69"	0.38"	3.00"	0.28"	---	---	1.00"	5
30UV45R	Reg	Tube	(50.8)	(25.4)	(77.7)	(217.4)	(38.9)	(28.4)	(17.5)	(9.7)	(76.2)	(7.1)	---	---	(25.4)	
30UV46V	Vee	1/4" H/P	2.00"	1.00"	2.38"	5.13"	---	1.12"	0.69"	0.38"	3.00"	0.28"	0.75"	1.47"	1.00"	6
30UV46R	Reg	Tube	(50.8)	(25.4)	(60.5)	(130.3)	---	(28.4)	(17.5)	(9.7)	(76.2)	(7.1)	(19.1)	(37.3)	(25.4)	
30MV46V	Meter	1/4" H/P	2.00"	1.00"	2.38"	5.42"	---	1.12"	0.69"	0.38"	3.00"	0.28"	0.75"	1.47"	1.00"	7
30MV46R	Reg	Tube	(50.8)	(25.4)	(60.5)	(137.7)	---	(28.4)	(17.5)	(9.7)	(76.2)	(7.1)	(19.1)	(37.3)	(25.4)	
30MMV46V	Micro-Meter	1/4" H/P	2.00"	1.00"	2.38"	6.10"	---	1.12"	0.69"	0.38"	3.00"	0.28"	0.75"	1.47"	1.00"	8
30MMV46R	Reg	Tube	(50.8)	(25.4)	(60.5)	(154.9)	---	(28.4)	(17.5)	(9.7)	(76.2)	(7.1)	(19.1)	(37.3)	(25.4)	

See page HP-1 for orifice and Cv

2-stem Manifold

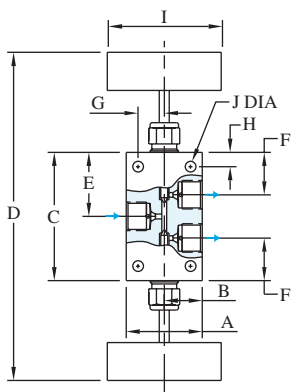

Figure 5

Replaceable Seat

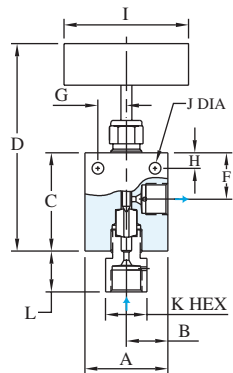

Figure 6

Metering

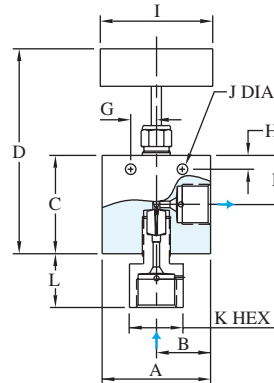

Figure 7

Micro-Metering

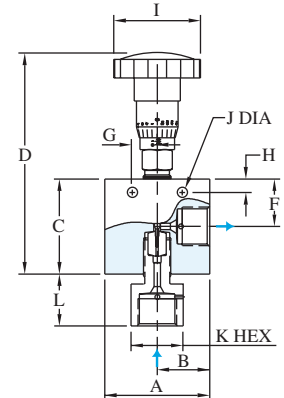

Figure 8

All dimensions are for reference only and are subject to change.
Dimensions in parentheses are millimeters (mm)

NEEDLE VALVES FOR 30,000 PSI (2070 BAR)

3/8" H/P TUBE, CONED AND THREADED

2-way Straight

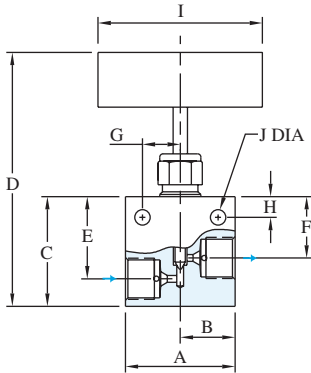

Figure 1

2-way Angle

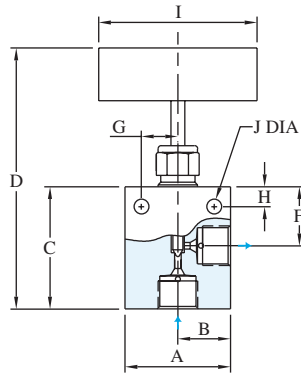

Figure 2

3-way Two on Pressure

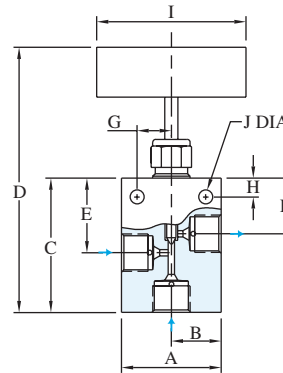

Figure 3

3-way One on Pressure

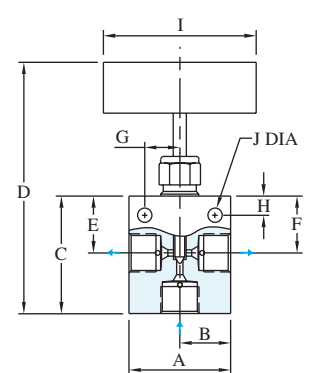

Figure 4

Catalog Number	Stem Style	Connection	A	B	C	D	E	F	G	H	I	J	K	L	Thk.	Fig
30UV61V	Vee	3/8" H/P	2.00"	1.00"	2.00"	4.75"	1.50"	1.12"	0.69"	0.38"	3.00"	0.28"	---	---	1.00"	1
30UV61R	Reg	Tube	(50.8)	(25.4)	(50.8)	(120.7)	(38.1)	(28.4)	(17.5)	(9.7)	(76.2)	(7.1)	---	---	(25.4)	
30UV62V	Vee	3/8" H/P	2.00"	1.00"	2.12"	4.87"	---	1.12"	0.69"	0.38"	3.00"	0.28"	---	---	1.00"	2
30UV62R	Reg	Tube	(50.8)	(25.4)	(53.8)	(123.7)	---	(28.4)	(17.5)	(9.7)	(76.2)	(7.1)	---	---	(25.4)	
30UV63V	Vee	3/8" H/P	2.00"	1.00"	2.50"	5.25"	1.50"	1.12"	0.69"	0.38"	3.00"	0.28"	---	---	1.00"	3
30UV63R	Reg	Tube	(50.8)	(25.4)	(63.5)	(133.4)	(38.1)	(28.4)	(17.5)	(9.7)	(76.2)	(7.1)	---	---	(25.4)	
30UV64V	Vee	3/8" H/P	2.00"	1.00"	2.12"	4.87"	1.12"	1.12"	0.69"	0.38"	3.00"	0.28"	---	---	1.00"	4
30UV64R	Reg	Tube	(50.8)	(25.4)	(53.8)	(123.7)	(28.4)	(28.4)	(17.5)	(9.7)	(76.2)	(7.1)	---	---	(25.4)	
30UV65V	Vee	3/8" H/P	2.00"	1.00"	3.25"	8.75"	1.62"	1.12"	0.69"	0.38"	3.00"	0.28"	---	---	1.00"	5
30UV65R	Reg	Tube	(50.8)	(25.4)	(82.6)	(222.3)	(41.1)	(28.4)	(17.5)	(9.7)	(76.2)	(7.1)	---	---	(25.4)	
30UV66V	Vee	3/8" H/P	2.00"	1.00"	2.38"	5.13"	---	1.12"	0.69"	0.38"	3.00"	0.28"	1.00"	1.15"	1.00"	6
30UV66R	Reg	Tube	(50.8)	(25.4)	(60.5)	(130.3)	---	(28.4)	(17.5)	(9.7)	(76.2)	(7.1)	(25.4)	(29.2)	(25.4)	
30MV66V	Meter	3/8" H/P	2.00"	1.00"	2.38"	5.42"	---	1.12"	0.69"	0.38"	3.00"	0.28"	1.00"	1.15"	1.00"	7
30MV66R	Reg	Tube	(50.8)	(25.4)	(60.5)	(137.7)	---	(28.4)	(17.5)	(9.7)	(76.2)	(7.1)	(25.4)	(29.2)	(25.4)	
30MMV66V	Micro-Meter	3/8" H/P	2.00"	1.00"	2.38"	6.10"	---	1.12"	0.69"	0.38"	3.00"	0.28"	1.00"	1.15"	1.00"	8
30MMV66R	Reg	Tube	(50.8)	(25.4)	(60.5)	(154.9)	---	(28.4)	(17.5)	(9.7)	(76.2)	(7.1)	(25.4)	(29.2)	(25.4)	

See page HP-1 for orifice and Cv

2-stem Manifold

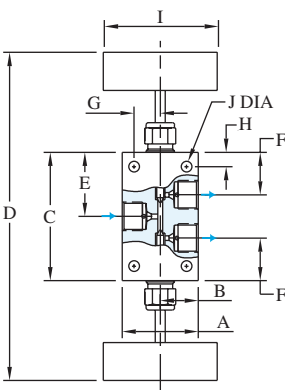

Figure 5

Replaceable Seat

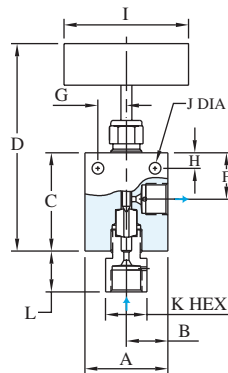

Figure 6

Metering

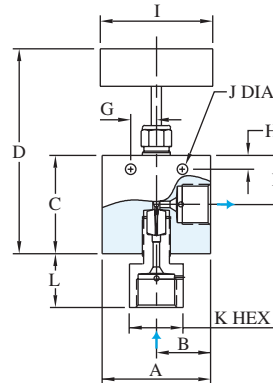

Figure 7

Micro-Metering

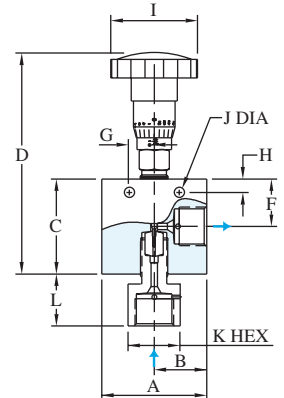

Figure 8

All dimensions are for reference only and are subject to change.
Dimensions in parentheses are millimeters (mm)

NEEDLE VALVES FOR 30,000 PSI (2070 BAR)

9/16" H/P TUBE, CONED AND THREADED

2-way Straight

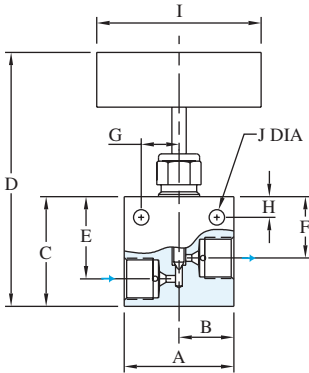

Figure 1

2-way Angle

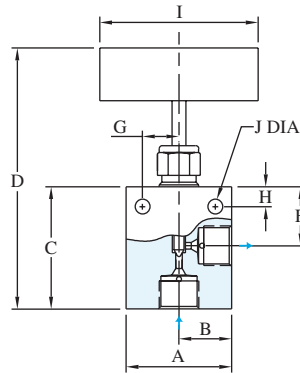

Figure 2

3-way Two on Pressure

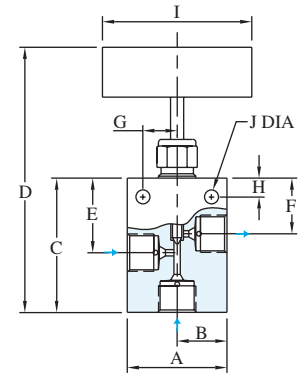

Figure 3

Catalog Number	Stem Style	Connection	A	B	C	D	E	F	G	H	I	J	K	L	Thk.	Fig
30UV91V	Vee	9/16" H/P	2.62"	1.31"	2.44"	5.19"	1.56"	1.12"	0.69"	0.38"	3.00"	0.28"	---	---	1.50"	1
30UV91R	Reg	Tube	(66.5)	(33.3)	(62.0)	(131.8)	(39.6)	(28.4)	(17.5)	(9.7)	(76.2)	(7.1)	---	---	(38.1)	
30UV92V	Vee	9/16" H/P	2.62"	1.31"	2.44"	5.75"	---	1.12"	0.69"	0.38"	3.00"	0.28"	---	---	1.50"	2
30UV92R	Reg	Tube	(66.5)	(33.3)	(62.0)	(146.1)	---	(28.4)	(17.5)	(9.7)	(76.2)	(7.1)	---	---	(38.1)	
30UV93V	Vee	9/16" H/P	2.62"	1.31"	2.88"	5.63"	1.56"	1.12"	0.69"	0.38"	3.00"	0.28"	---	---	1.50"	3
30UV93R	Reg	Tube	(66.5)	(33.3)	(73.2)	(143.0)	(39.6)	(28.4)	(17.5)	(9.7)	(76.2)	(7.1)	---	---	(38.1)	
30UV94V	Vee	9/16" H/P	2.62"	1.31"	2.44"	5.19"	1.12"	1.12"	0.69"	0.38"	3.00"	0.28"	---	---	1.50"	4
30UV94R	Reg	Tube	(66.5)	(33.3)	(62.0)	(131.8)	(28.4)	(28.4)	(17.5)	(9.7)	(76.2)	(7.1)	---	---	(38.1)	
30UV95V	Vee	9/16" H/P	2.62"	1.31"	4.75"	10.25"	2.38"	1.62"	0.69"	0.50"	3.00"	0.28"	---	---	1.50"	5
30UV95R	Reg	Tube	(66.5)	(33.3)	(120.7)	(260.4)	(60.5)	(41.1)	(17.5)	(12.7)	(76.2)	(7.1)	---	---	(38.1)	
30UV96V	Vee	9/16" H/P	2.62"	1.31"	2.44"	5.19"	---	1.19"	0.69"	0.38"	3.00"	0.28"	1.38"	1.65"	1.50"	6
30UV96R	Reg	Tube	(66.5)	(33.3)	(62.0)	(131.8)	---	(30.2)	(17.5)	(9.7)	(76.2)	(7.1)	(35.1)	(41.9)	(38.1)	

See page HP-1 for orifice and Cv

3-way One on Pressure

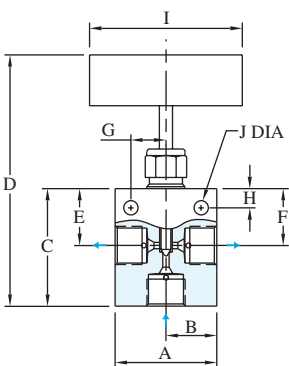

Figure 4

2-stem Manifold

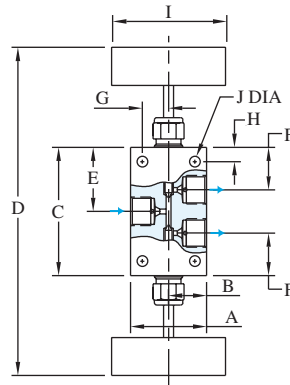

Figure 5

Replaceable Seat

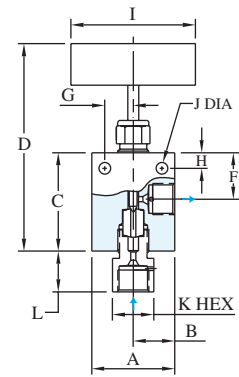

Figure 6

NEEDLE VALVES FOR 30,000 PSI (2070 BAR)

1" H/P TUBE, CONED AND THREADED

2-way Straight

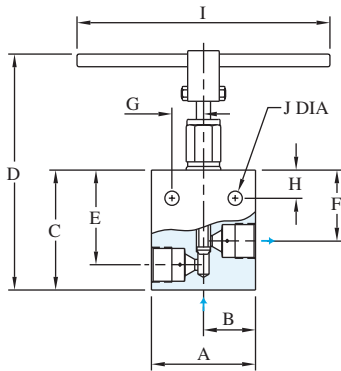

Figure 1

2-way Angle

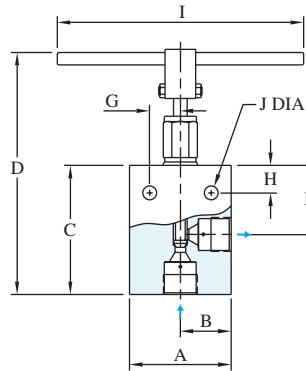

Figure 2

3-way Two on Pressure

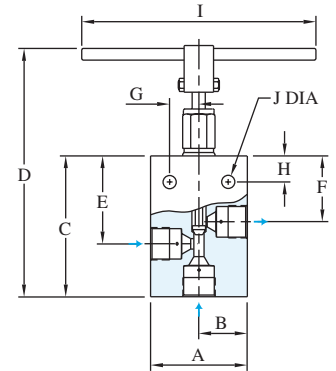

Figure 3

Catalog Number	Stem Style	Connection	A	B	C	D	E	F	G	H	I	J	K	L	Thk.	Fig
30V161V	Vee	1" H/P	4.12"	2.06"	4.75"	10.04"	3.75"	2.81"	1.25"	1.12"	10.00"	0.56"	---	---	1.75"	1
30V161R	Reg	Tube	(104.6)	(52.3)	(120.7)	(255.0)	(95.3)	(71.4)	(31.8)	(28.4)	(254.0)	(14.2)	---	---	(44.5)	
30V162V	Vee	1" H/P	4.12"	2.06"	5.25"	10.54"	---	2.81"	1.25"	1.12"	10.00"	0.56"	---	---	1.75"	2
30V162R	Reg	Tube	(104.6)	(52.3)	(133.4)	(267.7)	---	(71.4)	(31.8)	(28.4)	(254.0)	(14.2)	---	---	(44.5)	
30V163V	Vee	1" H/P	4.12"	2.06"	6.00"	11.25"	3.75"	2.81"	1.25"	1.12"	10.00"	0.56"	---	---	1.75"	3
30V163R	Reg	Tube	(104.6)	(52.3)	(152.4)	(285.8)	(95.3)	(71.4)	(31.8)	(28.4)	(254.0)	(14.2)	---	---	(44.5)	
30V164V	Vee	1" H/P	4.12"	2.06"	5.25"	10.54"	2.81"	2.81"	1.25"	1.12"	10.00"	0.56"	---	---	1.75"	4
30V164R	Reg	Tube	(104.6)	(52.3)	(133.4)	(267.7)	(71.4)	(71.4)	(31.8)	(28.4)	(254.0)	(14.2)	---	---	(44.5)	
30V165V	Vee	1" H/P	4.12"	2.06"	8.00"	18.58"	4.00"	2.81"	1.25"	1.12"	10.00"	0.56"	---	---	1.75"	5
30V165R	Reg	Tube	(104.6)	(52.3)	(203.2)	(471.9)	(101.6)	(71.4)	(31.8)	(28.4)	(254.0)	(14.2)	---	---	(44.5)	
30V166V	Vee	1" H/P	4.12"	2.06"	4.87"	10.16"	---	2.81"	1.25"	1.12"	10.00"	0.56"	1.75"	2.06"	1.75"	6
30V166R	Reg	Tube	(104.6)	(52.3)	(123.7)	(258.1)	---	(71.4)	(31.8)	(28.4)	(254.0)	(14.2)	(44.5)	(52.3)	(44.5)	

See page HP-1 for orifice and Cv

3-way One on Pressure

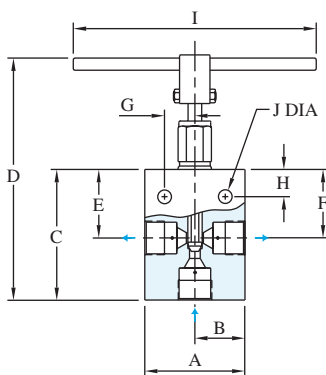

Figure 4

2-stem Manifold

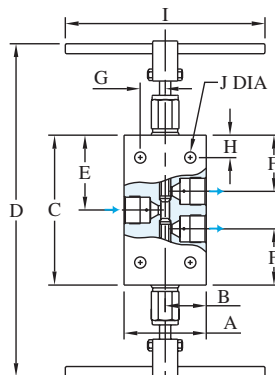

Figure 5

Replaceable Seat

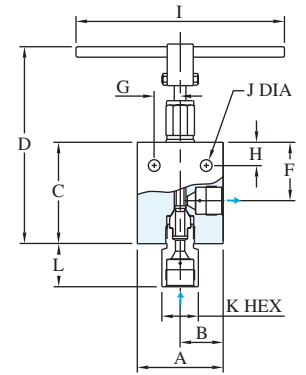

Figure 6



All dimensions are for reference only and are subject to change.
Dimensions in parentheses are millimeters (mm)

NEEDLE VALVES FOR 40,000 PSI (2760 BAR)

9/16" H/P TUBE, CONED AND THREADED

2-way Straight

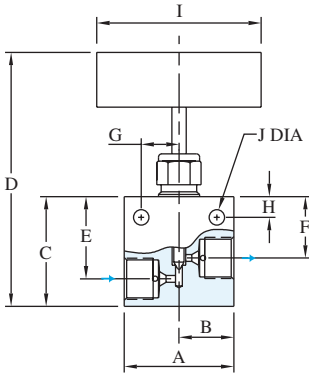

Figure 1

2-way Angle

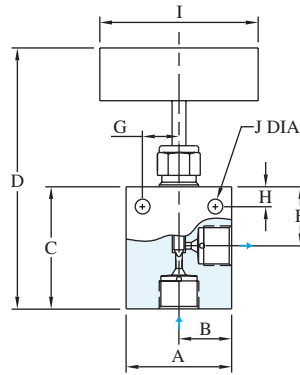

Figure 2

3-way Two on Pressure

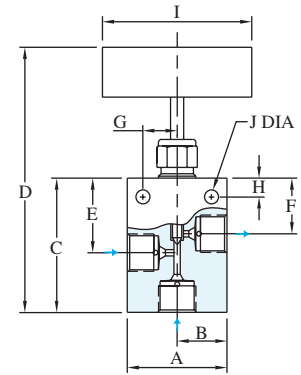

Figure 3

Catalog Number	Stem Style	Connection	A	B	C	D	E	F	G	H	I	J	K	L	Thk.	Fig
40UV91V	Vee	9/16" H/P	2.62"	1.31"	2.50"	5.25"	1.69"	1.31"	0.69"	0.38"	3.00"	0.28"	---	---	1.50"	1
40UV91R	Reg	Tube	(66.5)	(33.3)	(63.5)	(133.4)	(42.9)	(33.3)	(17.5)	(9.7)	(76.2)	(7.1)	---	---	(38.1)	
40UV92V	Vee	9/16" H/P	2.62"	1.31"	2.81"	5.56"	---	1.31"	0.69"	0.38"	3.00"	0.28"	---	---	1.50"	2
40UV92R	Reg	Tube	(66.5)	(33.3)	(71.4)	(141.2)	---	(33.3)	(17.5)	(9.7)	(76.2)	(7.1)	---	---	(38.1)	
40UV93V	Vee	9/16" H/P	2.62"	1.31"	3.03"	5.78"	1.75"	1.31"	0.69"	0.38"	3.00"	0.28"	---	---	1.50"	3
40UV93R	Reg	Tube	(66.5)	(33.3)	(77.0)	(146.8)	(44.5)	(33.3)	(17.5)	(9.7)	(76.2)	(7.1)	---	---	(38.1)	
40UV94V	Vee	9/16" H/P	2.62"	1.31"	2.81"	5.56"	1.31"	1.31"	0.69"	0.38"	3.00"	0.28"	---	---	1.50"	4
40UV94R	Reg	Tube	(66.5)	(33.3)	(71.4)	(141.2)	(33.3)	(33.3)	(17.5)	(9.7)	(76.2)	(7.1)	---	---	(38.1)	
40UV95V	Vee	9/16" H/P	2.62"	1.31"	4.12"	9.62"	2.06"	1.31"	0.69"	0.50"	3.00"	0.28"	---	---	1.50"	5
40UV95R	Reg	Tube	(66.5)	(33.3)	(104.6)	(244.3)	(52.3)	(33.3)	(17.5)	(12.7)	(76.2)	(7.1)	---	---	(38.1)	
40UV96V	Vee	9/16" H/P	2.62"	1.31"	2.62"	5.37"	---	1.31"	0.69"	0.38"	3.00"	0.28"	1.37"	1.39"	1.50"	6
40UV96R	Reg	Tube	(66.5)	(33.3)	(66.5)	(136.4)	---	(33.3)	(17.5)	(9.7)	(76.2)	(7.1)	(34.8)	(35.3)	(38.1)	

See page HP-1 for orifice and Cv

3-way One on Pressure

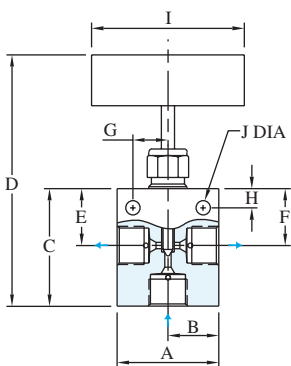

Figure 4

2-stem Manifold

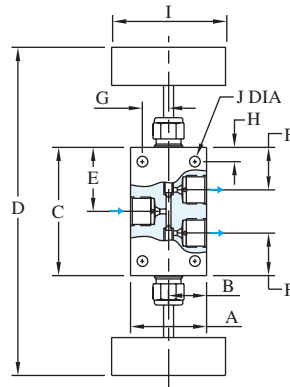

Figure 5

Replaceable Seat

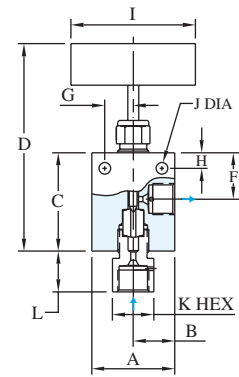

Figure 6

NEEDLE VALVES FOR 60,000 PSI (4140 BAR)

1/4" H/P TUBE, CONED AND THREADED

2-way Straight

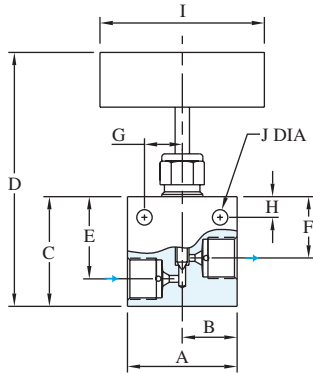

Figure 1

2-way Angle

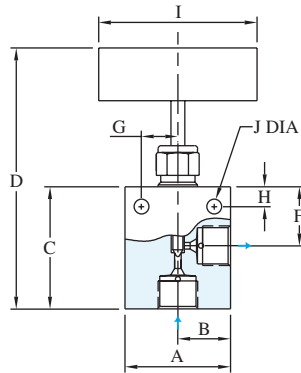

Figure 2

3-way Two on Pressure

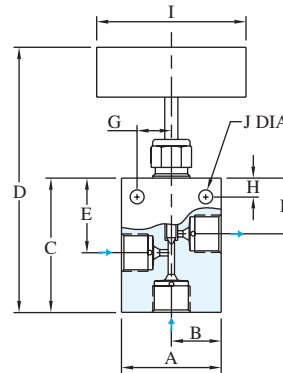

Figure 3

3-way One on Pressure

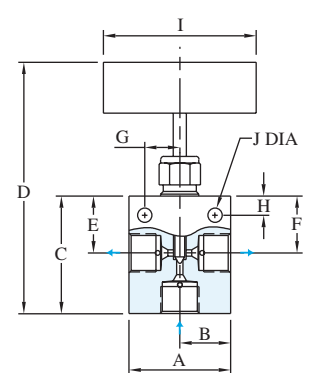

Figure 4

Catalog Number	Stem Style	Connection	A	B	C	D	E	F	G	H	I	J	K	L	Thk.	Fig
60UV41V 60UV41R	Vee Reg	1/4" H/P Tube	2.00" (50.8)	1.00" (25.4)	2.12" (53.8)	4.87" (123.7)	1.69" (42.9)	1.31" (33.3)	0.69" (17.5)	0.38" (9.7)	3.00" (76.2)	0.25" (6.4)	---	---	1.00" (25.4)	1
60UV42V 60UV42R	Vee Reg	1/4" H/P Tube	2.00" (50.8)	1.00" (25.4)	2.38" (60.5)	5.13" (130.3)	---	1.31" (33.3)	0.69" (17.5)	0.38" (9.7)	3.00" (76.2)	0.25" (6.4)	---	---	1.00" (25.4)	2
60UV43V 60UV43R	Vee Reg	1/4" H/P Tube	2.00" (50.8)	1.00" (25.4)	2.38" (60.5)	5.13" (130.3)	1.69" (42.9)	1.31" (33.3)	0.69" (17.5)	0.38" (9.7)	3.00" (76.2)	0.25" (6.4)	---	---	1.00" (25.4)	3
60UV44V 60UV44R	Vee Reg	1/4" H/P Tube	2.00" (50.8)	1.00" (25.4)	2.38" (60.5)	5.13" (130.3)	1.31" (33.3)	1.31" (33.3)	0.69" (17.5)	0.38" (9.7)	3.00" (76.2)	0.25" (6.4)	---	---	1.00" (25.4)	4
60UV45V 60UV45R	Vee Reg	1/4" H/P Tube	2.00" (50.8)	1.00" (25.4)	3.44" (87.4)	8.94" (227.1)	1.72" (43.7)	1.31" (33.3)	0.69" (17.5)	0.38" (9.7)	3.00" (76.2)	0.25" (6.4)	---	---	1.00" (25.4)	5
60UV46V 60UV46R	Vee Reg	1/4" H/P Tube	2.00" (50.8)	1.00" (25.4)	2.62" (66.5)	5.37" (136.4)	---	1.31" (33.3)	0.69" (17.5)	0.38" (9.7)	3.00" (76.2)	0.25" (6.4)	0.75" (19.1)	1.29" (32.8)	1.00" (25.4)	6
60MV46V	Meter	1/4" H/P Tube	2.00" (50.8)	1.00" (25.4)	2.62" (66.5)	6.95" (176.5)	---	1.31" (33.3)	0.69" (17.5)	0.38" (9.7)	3.00" (76.2)	0.25" (6.4)	0.75" (19.1)	1.29" (32.8)	1.00" (25.4)	7
60MMV46V	Micro-Meter	1/4" H/P Tube	2.00" (50.8)	1.00" (25.4)	2.62" (66.5)	7.63" (193.8)	---	1.31" (33.3)	0.69" (17.5)	0.38" (9.7)	3.00" (76.2)	0.25" (6.4)	0.75" (19.1)	1.29" (32.8)	1.00" (25.4)	8

See page HP-1 for orifice and Cv

2-stem Manifold

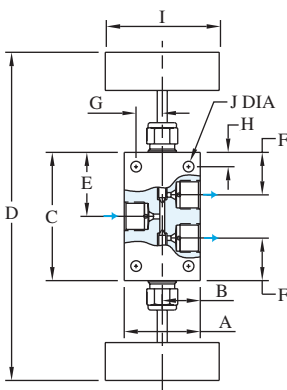

Figure 5

Replaceable Seat

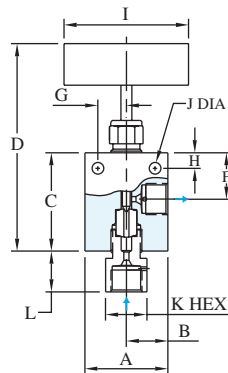

Figure 6

Metering

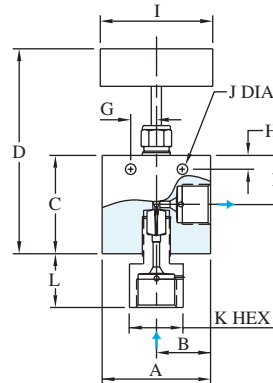

Figure 7

Micro-Metering

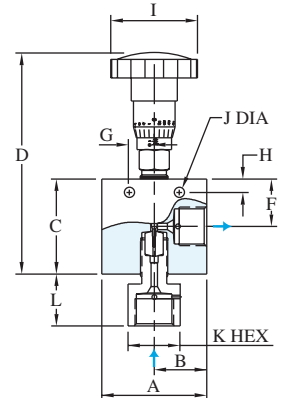

Figure 8

All dimensions are for reference only and are subject to change.
Dimensions in parentheses are millimeters (mm)

NEEDLE VALVES FOR 60,000 PSI (4140 BAR)

3/8" H/P TUBE, CONED AND THREADED

2-way Straight

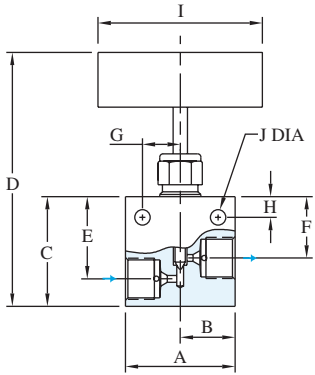

Figure 1

2-way Angle

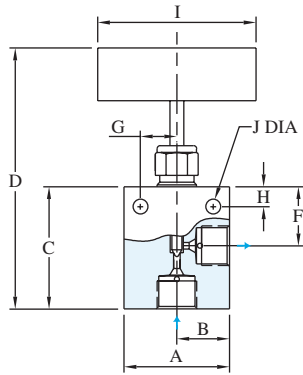

Figure 2

3-way Two on Pressure

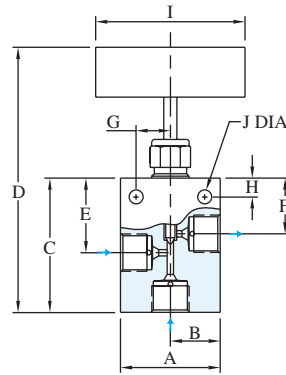

Figure 3

3-way One on Pressure

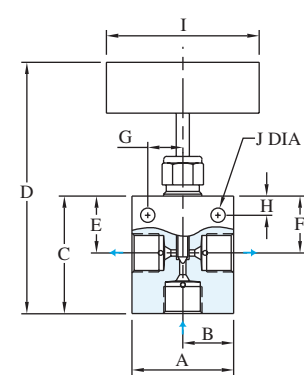

Figure 4

Catalog Number	Stem Style	Connection	A	B	C	D	E	F	G	H	I	J	K	L	Thk.	Fig
60UV61V	Vee	3/8" H/P	2.00"	1.00"	2.25"	5.00"	1.69"	1.31"	0.69"	0.38"	3.00"	0.25"	---	---	1.00"	1
60UV61R	Reg	Tube	(50.8)	(25.4)	(57.2)	(127.0)	(42.9)	(33.3)	(17.5)	(9.7)	(76.2)	(6.4)	---	---	(25.4)	
60UV62V	Vee	3/8" H/P	2.00"	1.00"	2.62"	5.37"	---	1.31"	0.69"	0.38"	3.00"	0.25"	---	---	1.00"	2
60UV62R	Reg	Tube	(50.8)	(25.4)	(66.5)	(136.4)	---	(33.3)	(17.5)	(9.7)	(76.2)	(6.4)	---	---	(25.4)	
60UV63V	Vee	3/8" H/P	2.00"	1.00"	2.75"	5.50"	1.69"	1.31"	0.69"	0.38"	3.00"	0.25"	---	---	1.00"	3
60UV63R	Reg	Tube	(50.8)	(25.4)	(69.9)	(139.7)	(42.9)	(33.3)	(17.5)	(9.7)	(76.2)	(6.4)	---	---	(25.4)	
60UV64V	Vee	3/8" H/P	2.00"	1.00"	2.62"	5.37"	1.31"	1.31"	0.69"	0.38"	3.00"	0.25"	---	---	1.00"	4
60UV64R	Reg	Tube	(50.8)	(25.4)	(66.5)	(136.4)	(33.3)	(33.3)	(17.5)	(9.7)	(76.2)	(6.4)	---	---	(25.4)	
60UV65V	Vee	3/8" H/P	2.00"	1.00"	3.75"	9.25"	1.88"	1.31"	0.69"	0.38"	3.00"	0.25"	---	---	1.00"	5
60UV65R	Reg	Tube	(50.8)	(25.4)	(95.3)	(235.0)	(47.8)	(33.3)	(17.5)	(9.7)	(76.2)	(6.4)	---	---	(25.4)	
60UV66V	Vee	3/8" H/P	2.00"	1.00"	2.62"	5.37"	---	1.31"	0.69"	0.38"	3.00"	0.25"	1.00"	1.21"	1.00"	6
60UV66R	Reg	Tube	(50.8)	(25.4)	(66.5)	(136.4)	---	(33.3)	(17.5)	(9.7)	(76.2)	(6.4)	(25.4)	(30.7)	(25.4)	
60MV66V	Meter	3/8" H/P	2.50"	1.25"	2.62"	6.95"	---	1.31"	0.69"	0.38"	3.00"	0.25"	1.00"	1.21"	1.00"	7
		Tube	(63.5)	(31.8)	(66.5)	(176.5)	---	(33.3)	(17.5)	(9.7)	(76.2)	(6.4)	(25.4)	(30.7)	(25.4)	
60MMV66V	Micro-Meter	3/8" H/P	2.00"	1.00"	2.62"	7.63"	---	1.31"	0.69"	0.38"	3.00"	0.25"	1.00"	1.21"	1.00"	8
		Tube	(50.8)	(25.4)	(66.5)	(193.8)	---	(33.3)	(17.5)	(9.7)	(76.2)	(6.4)	(25.4)	(30.7)	(25.4)	

See page HP-1 for orifice and Cv

2-stem Manifold

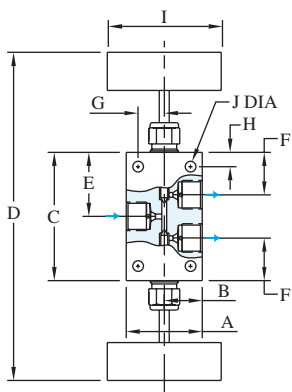

Figure 5

Replaceable Seat

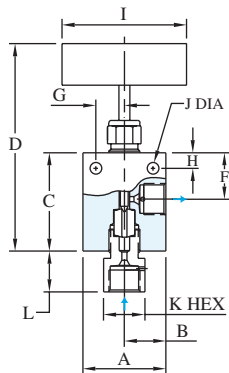

Figure 6

Metering

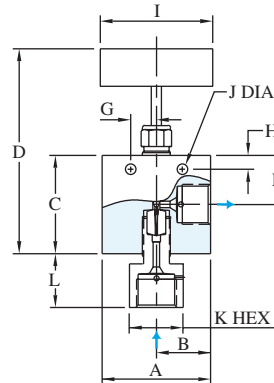

Figure 7

Micro-Metering

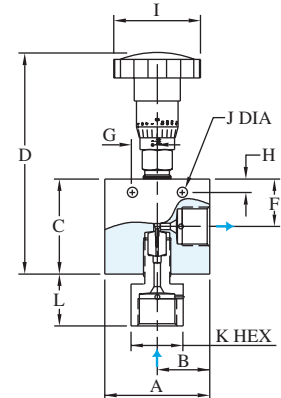

Figure 8

All dimensions are for reference only and are subject to change.
Dimensions in parentheses are millimeters (mm)

NEEDLE VALVES FOR 60,000 PSI (4140 BAR)

9/16" H/P TUBE, CONED AND THREADED

2-way Straight

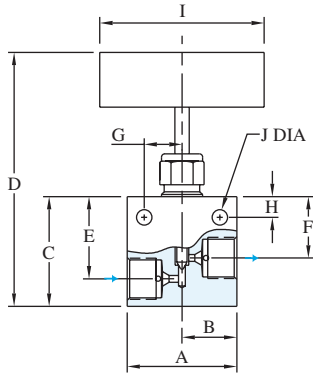

Figure 1

2-way Angle

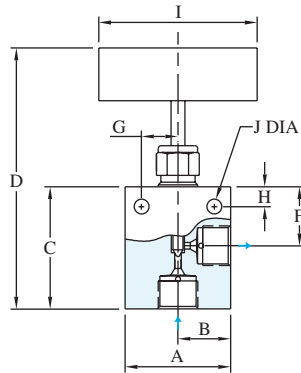

Figure 2

3-way Two on Pressure

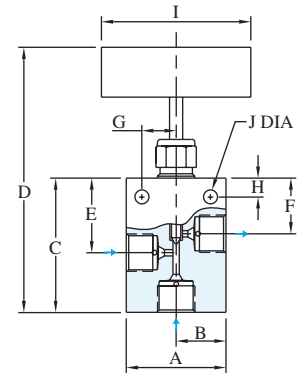

Figure 3

Catalog Number	Stem Style	Connection	A	B	C	D	E	F	G	H	I	J	K	L	Thk.	Fig
60UV91V	Vee	9/16" H/P	2.62"	1.31"	2.50"	5.25"	1.69"	1.31"	0.69"	0.38"	3.00"	0.28"	---	---	1.50"	1
60UV91R	Reg	Tube	(66.5)	(33.3)	(63.5)	(133.4)	(42.9)	(33.3)	(17.5)	(9.7)	(76.2)	(7.1)	---	---	(38.1)	
60UV92V	Vee	9/16" H/P	2.62"	1.31"	2.81"	5.56"	---	1.31"	0.69"	0.38"	3.00"	0.28"	---	---	1.50"	2
60UV92R	Reg	Tube	(66.5)	(33.3)	(71.4)	(141.2)	---	(33.3)	(17.5)	(9.7)	(76.2)	(7.1)	---	---	(38.1)	
60UV93V	Vee	9/16" H/P	2.62"	1.31"	3.03"	5.78"	1.75"	1.31"	0.69"	0.38"	3.00"	0.28"	---	---	1.50"	3
60UV93R	Reg	Tube	(66.5)	(33.3)	(77.0)	(146.8)	(44.5)	(33.3)	(17.5)	(9.7)	(76.2)	(7.1)	---	---	(38.1)	
60UV94V	Vee	9/16" H/P	2.62"	1.31"	2.81"	5.56"	1.31"	1.31"	0.69"	0.38"	3.00"	0.28"	---	---	1.50"	4
60UV94R	Reg	Tube	(66.5)	(33.3)	(71.4)	(141.2)	(33.3)	(33.3)	(17.5)	(9.7)	(76.2)	(7.1)	---	---	(38.1)	
60UV95V	Vee	9/16" H/P	2.62"	1.31"	4.12"	9.62"	2.06"	1.31"	0.69"	0.50"	3.00"	0.28"	---	---	1.50"	5
60UV95R	Reg	Tube	(66.5)	(33.3)	(104.6)	(244.3)	(52.3)	(33.3)	(17.5)	(12.7)	(76.2)	(7.1)	---	---	(38.1)	
60UV96V	Vee	9/16" H/P	2.62"	1.31"	2.62"	5.37"	---	1.31"	0.69"	0.38"	3.00"	0.28"	1.37"	1.39"	1.50"	6
60UV96R	Reg	Tube	(66.5)	(33.3)	(66.5)	(136.4)	---	(33.3)	(17.5)	(9.7)	(76.2)	(7.1)	(34.8)	(35.3)	(38.1)	

See page HP-1 for orifice and Cv

3-way One on Pressure

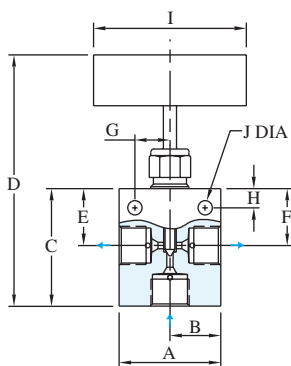

Figure 4

2-stem Manifold

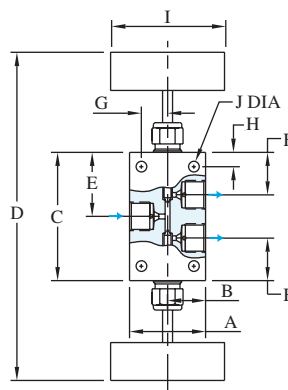

Figure 5

Replaceable Seat

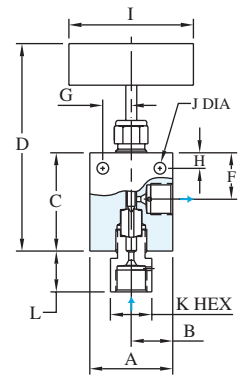
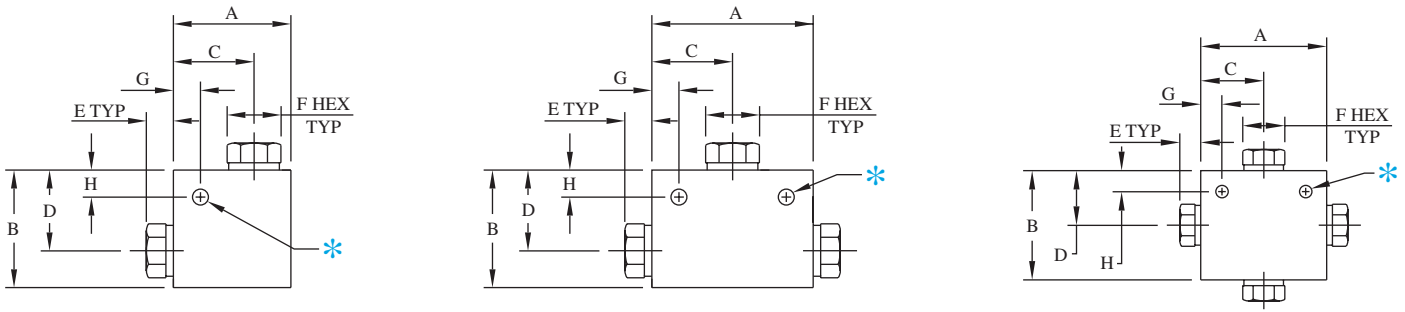

Figure 6

HIGH PRESSURE EQUIPMENT



ELBOWS

Catalog											Mounting Holes*		
Number	Connection	Port	MAWP	A	B	C	D	E	F	Block Thickness	G	H	Dia.
60L4	1/4" H/P Tube	0.093" (2.4)	60,000 PSI 4140 bar	1.50" (38.1)	1.00" (25.4)	0.88" (22.4)	0.63" (16.0)	0.50" (12.7)	0.62" (15.7)	1.00" (25.4)	0.25" (6.4)	0.15" (3.8)	0.22" (5.6)
60L6	3/8" H/P Tube	0.125" (3.2)	60,000 PSI 4140 bar	2.00" (50.8)	1.50" (38.1)	1.25" (31.8)	1.00" (25.4)	0.60" (15.2)	0.81" (20.6)	1.00" (25.4)	0.38" (9.7)	0.31" (7.9)	0.22" (5.6)
60L9	9/16" H/P Tube	0.187" (4.7)	60,000 PSI 4140 bar	2.62" (66.5)	1.88" (47.8)	1.88" (47.8)	1.13" (28.6)	0.81" (20.6)	1.18" (30.0)	1.50" (38.1)	2.32" (58.9)	1.38" (35.1)	0.28" (7.1)
40L9	9/16" H/P Tube	0.250" (6.4)	40,000 PSI 2760 bar	2.62" (66.5)	1.88" (47.8)	1.88" (47.8)	1.13" (28.7)	0.81" (20.6)	1.18" (30.0)	1.50" (38.1)	2.37" (60.2)	1.62" (41.1)	0.28" (7.1)
30L16	1" H/P Tube	0.438" (11.1)	30,000 PSI 2070 bar	3.00" (76.2)	3.00" (76.2)	2.06" (52.3)	2.06" (52.3)	0.72" (18.3)	1.38" (35.1)	1.75" (44.5)	0.69" (17.5)	0.69" (17.5)	0.41" (10.3)

TEES

Catalog											Mounting Holes*		
Number	Connection	Port	MAWP	A	B	C	D	E	F	Block Thickness	G	H	Dia.
60T4	1/4" H/P Tube	0.093" (2.4)	60,000 PSI 4140 bar	2.00" (50.8)	1.25" (31.8)	1.00" (25.4)	0.88" (22.4)	0.50" (12.7)	0.62" (15.7)	1.00" (25.4)	0.25" (6.4)	0.12" (3.0)	0.17" (4.3)
60T6	3/8" H/P Tube	0.125" (3.2)	60,000 PSI 4140 bar	2.00" (50.8)	1.56" (39.6)	1.00" (25.4)	1.06" (26.9)	0.60" (15.2)	0.81" (20.6)	1.00" (25.4)	0.31" (7.9)	0.31" (7.9)	0.22" (5.6)
60T9	9/16" H/P Tube	0.187" (4.7)	60,000 PSI 4140 bar	2.62" (66.5)	2.12" (53.8)	1.31" (33.3)	1.38" (35.1)	0.81" (20.6)	1.18" (30.0)	1.50" (38.1)	0.37" (9.4)	0.38" (9.5)	0.28" (7.1)
40T9	9/16" H/P Tube	0.250" (6.4)	40,000 PSI 2760 bar	2.62" (66.5)	2.12" (53.8)	1.31" (33.3)	1.38" (35.1)	0.81" (20.6)	1.18" (30.0)	1.50" (38.1)	0.37" (9.4)	0.38" (9.7)	0.28" (7.1)
30T16	1" H/P Tube	0.438" (11.1)	30,000 PSI 2070 bar	4.12" (104.6)	3.00" (76.2)	2.06" (52.3)	2.06" (52.3)	0.72" (18.3)	1.38" (35.1)	1.75" (44.5)	0.69" (17.5)	0.69" (17.5)	0.41" (10.4)

CROSSES

Catalog											Mounting Holes*		
Number	Connection	Port	MAWP	A	B	C	D	E	F	Block Thickness	G	H	Dia.
60X4	1/4" H/P Tube	0.093" (2.4)	60,000 PSI 4140 bar	2.00" (50.8)	1.25" (31.8)	1.00" (25.4)	0.62" (15.7)	0.50" (12.7)	0.62" (15.7)	1.00" (25.4)	0.25" (6.4)	0.12" (3.0)	0.17" (4.3)
60X6	3/8" H/P Tube	0.125" (3.2)	60,000 PSI 4140 bar	2.00" (50.8)	2.12" (53.8)	1.00" (25.4)	1.06" (26.9)	0.60" (15.2)	0.81" (20.6)	1.00" (25.4)	0.31" (7.9)	0.31" (7.9)	0.22" (5.6)
60X9	9/16" H/P Tube	0.187" (4.7)	60,000 PSI 4140 bar	2.62" (66.5)	2.75" (69.9)	1.31" (33.3)	1.38" (35.1)	0.81" (20.6)	1.18" (30.0)	1.50" (38.1)	0.38" (9.7)	0.38" (9.5)	0.28" (7.1)
40X9	9/16" H/P Tube	0.250" (6.4)	40,000 PSI 2760 bar	2.62" (66.5)	2.75" (69.9)	1.31" (33.3)	1.38" (35.1)	0.81" (20.6)	1.18" (30.0)	1.50" (38.1)	0.37" (9.4)	0.38" (9.7)	0.28" (7.1)
30X16	1" H/P Tube	0.438" (11.1)	30,000 PSI 2070 bar	4.12" (104.6)	4.12" (104.6)	2.06" (52.3)	2.06" (52.3)	0.72" (18.3)	1.38" (35.1)	1.75" (44.5)	0.69" (17.5)	0.69" (17.5)	0.41" (10.3)

*Mounting holes provided when the catalog number is suffixed by "-MH" when ordering.

All dimensions are for reference only and are subject to change.
Dimensions in parentheses are millimeters (mm)

HIGH PRESSURE EQUIPMENT

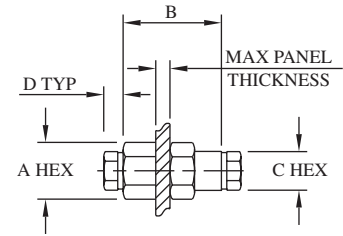
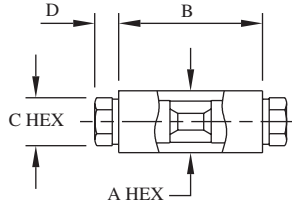
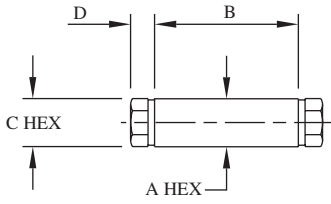

See bulkhead table below for panel hole drill size

COUPLINGS

Catalog Number	Connection	Port	MAWP	A	B	C	D
60F4	1/4" H/P Tube	0.093" (2.4)	60,000 PSI 4140 bar	0.75" (19.1)	1.38" (35.1)	0.63" (16.0)	0.50" (12.7)
60F6	3/8" H/P Tube	0.125" (3.2)	60,000 PSI 4140 bar	1.00" (25.4)	1.75" (44.5)	0.81" (20.6)	0.60" (15.2)
60F9	9/16" H/P Tube	0.187" (4.7)	60,000 PSI 4140 bar	1.37" (34.8)	2.25" (57.2)	1.18" (30.0)	0.81" (20.6)
40F9	9/16" H/P Tube	0.250" (6.4)	40,000 PSI 2760 bar	1.37" (34.8)	2.25" (57.2)	1.18" (30.0)	0.81" (20.6)
30F16	1" H/P Tube	0.438" (11.1)	30,000 PSI 2070 bar	1.75" (44.5)	3.75" (95.3)	1.38" (35.1)	0.72" (18.3)

REPLACEABLE SEAT COUPLINGS

Catalog Number	Connection	Port	MAWP	A	B	C	D
60UF4	1/4" H/P Tube	0.093" (2.4)	60,000 PSI 4140 bar	0.75" (19.1)	1.50" (38.1)	0.63" (16.0)	0.50" (12.7)
60UF6	3/8" H/P Tube	0.125" (3.2)	60,000 PSI 4140 bar	1.38" (35.1)	1.75" (44.5)	0.81" (20.6)	0.60" (15.2)
60UF9	9/16" H/P Tube	0.187" (4.7)	60,000 PSI 4140 bar	1.38" (35.1)	2.25" (57.2)	1.18" (30.0)	0.81" (20.6)
40UF9	9/16" H/P Tube	0.250" (6.4)	40,000 PSI 2760 bar	1.38" (35.1)	2.25" (57.2)	1.18" (30.0)	0.81" (20.6)
30UF16	1" H/P Tube	0.438" (11.1)	30,000 PSI 2070 bar	1.75" (44.5)	3.75" (95.3)	1.38" (35.1)	0.72" (18.3)

BULKHEADS

Catalog Number	Connection	Port	MAWP	A	B	C	D	Max Panel Thickness	Panel Hole
60BF4	1/4" H/P Tube	0.093" (2.4)	60,000 PSI 4140 bar	1.00" (25.4)	2.00" (50.8)	0.63" (16.0)	0.50" (12.7)	0.50" (12.7)	0.94" (23.0)
60BF6	3/8" H/P Tube	0.125" (3.2)	60,000 PSI 4140 bar	1.38" (35.1)	2.38" (60.5)	0.81" (20.6)	0.60" (15.2)	0.38" (9.7)	1.12" (28.4)
60BF9	9/16" H/P Tube	0.187" (4.7)	60,000 PSI 4140 bar	1.87" (47.5)	2.75" (69.9)	1.18" (30.0)	0.81" (20.6)	0.62" (15.7)	1.75" (44.5)
40BF9	9/16" H/P Tube	0.250" (6.4)	40,000 PSI 2760 bar	1.87" (47.5)	2.75" (69.9)	1.18" (30.0)	0.81" (20.6)	0.62" (15.7)	1.75" (44.5)
30BF16	1" H/P Tube	0.438" (11.1)	30,000 PSI 2070 bar	2.12" (53.8)	3.50" (88.9)	1.38" (35.1)	0.72" (18.3)	0.50" (12.7)	2.00" (50.8)

All dimensions are for reference only and are subject to change.
Dimensions in parentheses are millimeters (mm)



HIGH PRESSURE NIPPLES AND TUBING

Coned and Threaded Nipples

BuTech stocks pre-cut coned and threaded nipples in lengths up to 12" (305 mm). In addition, nipples can be purchased to any custom length.

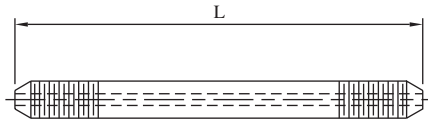

Connection	Length							MAWP
	2.75" (69.9)	3.00" (76.2)	4.00" (101.6)	6.00" (152.4)	8.00" (203.2)	10.00" (254.0)	12.00" (304.8)	
1/4" H/P	60N442-*	60N443-*	60N444-*	60N446-*	60N448-*	60N4410-*	60N4412-*	60,000 PSI 4140 bar
3/8" H/P		60N663-*	60N664-*	60N666-*	60N668-*	60N6610-*	60N6612-*	60,000 PSI 4140 bar
9/16" H/P 0.188" orifice			60N994-*	60N996-*	60N998-*	60N9910-*	60N9912-*	60,000 PSI 4140 bar
9/16" H/P 0.250" orifice			40N994-*	40N996-*	40N998-*	40N9910-*	40N9912-*	40,000 PSI 2760 bar
1" H/P				30N166-*	30N168-*	30N1610-*	30N1612-*	30,000 PSI 2070 bar

*Complete catalog number by adding suffix **316** for 316 stainless steel or suffix **304** for 304 stainless steel

Tubing

Catalog Number	Connection	O.D.	I.D.	MAWP
60-083-*	1/4" H/P	0.250" (6.4)	0.083" (2.1)	60,000 PSI 4140 bar
60-125-*	3/8" H/P	0.375" (9.5)	0.125" (3.2)	60,000 PSI 4140 bar
60-188-*	9/16" H/P	0.562" (14.3)	0.188" (4.8)	60,000 PSI 4140 bar
40-250-*	9/16" H/P	0.562" (14.3)	0.250" (6.4)	40,000 PSI 2760 bar
30-438-*	1" H/P	1.000" (25.4)	0.438" (11.1)	30,000 PSI 2070 bar

*Complete catalog number by adding suffix **316** for 316 stainless steel or suffix **304** for 304 stainless steel. Other materials are also available, please consult factory.

BuTech offers a complete selection of austenitic seamless cold-drawn stainless steel tubing for high pressure applications where both high strength and corrosion resistance are desired. Tubing is available in standard 20-24 foot lengths (6-7 meters), however, longer lengths are available on request.



See Section T for Coning Tools, Threading Tools and Tube Vises!

HIGH PRESSURE CONNECTION COMPONENTS

Connection Components

All BuTech valves and fittings are supplied with glands and collars. To order these components separately, use catalog numbers listed below. When using a plug, the collar is not required.

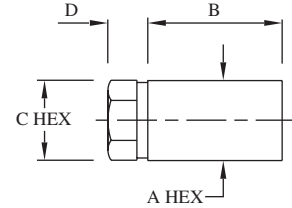

Tube Size	Collar	Gland	Plug
1/4" H/P	60C4	60G4	60P4
3/8" H/P	60C6	60G6	60P6
9/16" H/P 60,000 PSI	60C9	60G9	60P9
9/16" H/P 40,000 PSI	60C9	60G9	40P9
1" H/P	20C16	20G16	30P16

Cap	A	B	C	D
60CA4	0.75" (19.1)	1.06" (26.9)	0.63" (16.0)	0.60" (15.2)
60CA6	1.00" (25.4)	1.25" (31.8)	0.81" (20.6)	0.72" (18.3)
60CA9	1.38" (35.1)	1.62" (41.1)	1.18" (30.0)	0.96" (24.4)
40CA9	1.38" (35.1)	1.62" (41.1)	1.18" (30.0)	0.96" (24.4)
30CA16	1.75" (44.5)	2.25" (57.2)	1.38" (35.1)	0.69" (17.5)

Anti-Vibration Collet Glands

In standard high pressure connection systems, the bending stresses imposed by excessive vibration or shock on the the threaded area of the tubing may cause premature fatigue failure at the back of the thread. By using a BuTech Anti-Vibration Collet Gland, the stress concentration is transferred back to the unthreaded section of the tubing. This transfer and the spring-type gripping action of the collet, strengthens the entire assembly, resulting in virtually unlimited vibration fatigue life. Anti-Vibration Collet Glands are recommended whenever locating a valve or fitting on an unsupported line near a compressor, on equipment subjected to road vibrations, or areas where extreme shock is present.

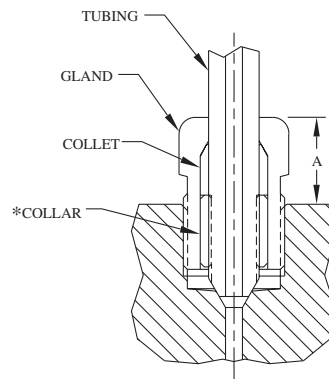

For 1/4", 3/8" & 9/16" Tube

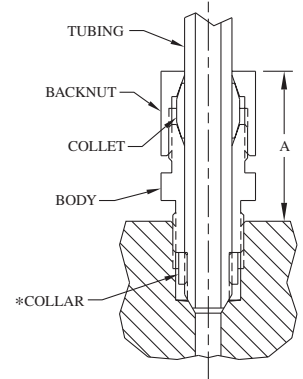

For 1" Tube

Connection	Catalog Number	Gland Hex Size	Height 'A'	Collar*
1/4" H/P	60AVG4	0.62" (15.7)	0.50" (12.7)	60C4
3/8" H/P	60AVG6	0.81" (20.6)	0.75" (19.1)	60C6
9/16" H/P	60AVG9	1.18" (30.0)	0.94" (23.9)	60C9
1" H/P	20AVCG16	1.50" (38.1)	1.75" (44.5)	20C16

Anti-vibration glands are manufactured of 316 stainless steel and are available with an optional bonded dry-film Moly lubricant (add suffix **-MC** to catalog number)

*Collars are not included with anti-vibration assembly and must be ordered separately.

HIGH PRESSURE CHECK VALVES

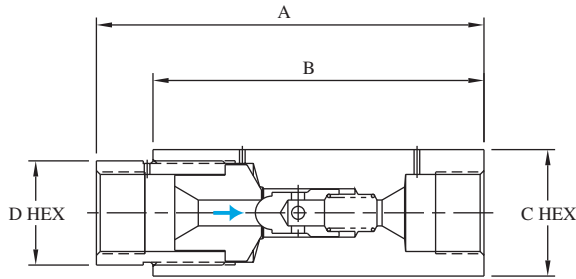

BuTech ball check valves prevent reverse flow where leak-tight shutoff is not necessary. Standard materials of construction are 316 stainless steel with 17-4PH poppet for longer life, and 300 series stainless steel spring.

Note: For 316ss wetted parts, add **-316WP** to the catalog number.

Cracking pressure: 15 PSI (1 bar) approximate

Operating Temperature Range:

-420° to +1200°F

(-251° to +648°C)

BALL CHECK VALVES

Catalog Number	Connection	MAWP	Cv	A	B	C	D
60BC4	1/4" H/P Tube	60,000 PSI 4140 bar	0.15	3.31" (84.1)	2.50" (63.5)	1.12" (28.4)	0.88" (22.2)
60BC6	3/8" H/P Tube	60,000 PSI 4140 bar	0.28	3.75" (95.3)	3.00" (76.2)	1.38" (34.9)	1.12" (28.4)
60BC9	9/16" H/P Tube	60,000 PSI 4140 bar	0.63	4.57" (116.1)	3.38" (85.9)	1.50" (38.1)	1.38" (34.9)
40BC9	9/16" H/P Tube	40,000 PSI 2760 bar	1.00	4.57" (116.1)	3.38" (85.9)	1.50" (38.1)	1.38" (35.1)
30BC16	1" H/P Tube	30,000 PSI 2070 bar	3.40	6.50" (165.1)	5.55" (141.0)	1.75" (44.5)	2.13" (54.1)

To order a valve with a cracking pressure other than the standard 15 PSI, add the cracking pressure to the end of the catalog number. Example: A 60BC9 with 50 PSI cracking pressure would be ordered as **60BC9-50**.

Cracking pressures available up to 100 PSI (7 bar)

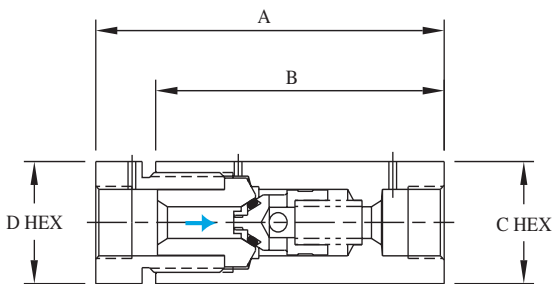

BuTech o-ring check valves reliably prevent backflow where leak-tight shutoff for liquids or gases is required. Standard materials of construction are 316 stainless steel with Buna-N o-ring and 300 series stainless steel spring.

Cracking pressure: 15 PSI (1 bar) approximate

Operating Temperature Ranges:

O-ring Material	Operating Temperature Range	Catalog Suffix
Buna-N	-65° to +250°F (-54° to +121°C)	----
Viton	-40° to +500°F (-40° to +260°C)	-VA
Teflon	-320° to +400°F (-195° to +204°C)	-TFE
Kalrez	-20° to +550°F (-29° to +288°C)	-HT

O-RING CHECK VALVES

Catalog Number	Connection	MAWP	Cv	A	B	C	D
60SC4	1/4" H/P Tube	60,000 PSI 4140 bar	0.15	3.31" (84.1)	2.50" (63.5)	1.12" (28.4)	0.88" (22.2)
60SC6	3/8" H/P Tube	60,000 PSI 4140 bar	0.28	3.75" (95.3)	3.00" (76.2)	1.38" (34.9)	1.12" (28.4)
60SC9	9/16" H/P Tube	60,000 PSI 4140 bar	0.63	4.57" (116.1)	3.38" (85.9)	1.50" (38.1)	1.38" (34.9)
40SC9	9/16" H/P Tube	40,000 PSI 2760 bar	1.00	4.57" (116.1)	3.38" (85.9)	1.50" (38.1)	1.38" (35.1)
30SC16	1" H/P Tube	30,000 PSI 2070 bar	3.40	6.50" (165.1)	5.55" (141.0)	2.13" (54.1)	1.75" (44.5)

To order a valve with a cracking pressure other than the standard 15 PSI, add the cracking pressure to the end of the catalog number. Example: A 60SC4 with 40 PSI cracking pressure would be ordered as **60SC4-40**.

Cracking pressures available up to 100 PSI (7 bar)

All dimensions are for reference only and are subject to change.
Dimensions in parentheses are millimeters (mm)

HIGH PRESSURE FILTERS

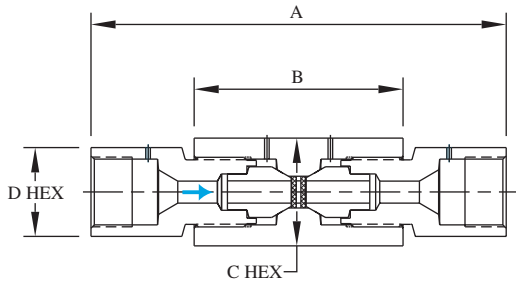

BuTech line filters are used in system lines to remove contaminating particles from the system fluid. Upstream filter of larger micron rating than downstream filter to prevent clogging of downstream filter.

Standard materials of construction are 316 stainless steel with 300 series stainless steel filter discs. Available in nominal ratings of: 0.5, 2, 5, 10, 20, 40, and 100 micron.

LINE FILTERS

Catalog Number	Connection	MAWP	Area*	A	B	C	D
60LF4	1/4" H/P Tube	60,000 PSI 4140 bar	0.15 in ² 97 mm ²	4.06" (103.1)	2.62" (66.5)	1.38" (34.9)	0.88" (22.4)
60LF6	3/8" H/P Tube	60,000 PSI 4140 bar	0.15 in ² 97 mm ²	4.56" (115.8)	2.62" (66.5)	1.38" (34.9)	1.00" (25.4)
60LF9	9/16" H/P Tube	60,000 PSI 4140 bar	0.15 in ² 97 mm ²	6.00" (152.4)	3.62" (91.9)	1.50" (38.1)	1.38" (35.1)
40LF9	9/16" H/P Tube	40,000 PSI 2760 bar	0.22 in ² 142 mm ²	6.00" (152.4)	3.62" (91.9)	1.50" (38.1)	1.38" (35.1)
30LF16	1" H/P Tube	30,000 PSI 2070 bar	0.50 in ² 323 mm ²	8.18" (207.8)	4.12" (104.6)	2.13" (54.1)	1.75" (44.5)

*Effective area of filter element

Micron rating of filter must be specified. To order, complete the catalog number with the desired micron rating, upstream first:

60LF4-40/20

specifies a line filter with 1/4" H/P connections, a 40 micron filter upstream and 20 micron downstream.

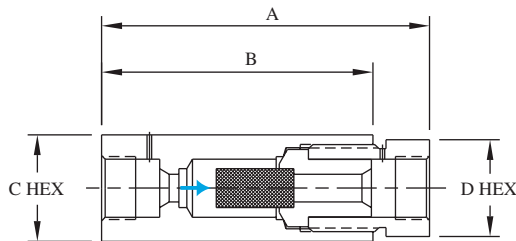

BuTech sintered cup filters offer maximum filtration surface area for removal of contaminating particles from the fluid system. They may be used in systems which require high flow rates with minimum pressure drop.

Standard materials of construction are 316 stainless steel with 300 series stainless steel filter discs. Available in nominal ratings of: 5, 10, 20, 40, and 100 micron.

SINTERED CUP FILTERS

Catalog Number	Connection	MAWP	Area*	A	B	C	D
60SCF4	1/4" H/P Tube	60,000 PSI 4140 bar	0.44 in ² 284 mm ²	3.32" (84.3)	2.50" (63.5)	1.12" (28.4)	0.88" (22.2)
60SCF6	3/8" H/P Tube	60,000 PSI 4140 bar	0.54 in ² 348 mm ²	3.75" (95.3)	3.00" (76.2)	1.38" (34.9)	1.12" (28.4)
60SCF9	9/16" H/P Tube	60,000 PSI 4140 bar	0.86 in ² 555 mm ²	4.70" (119.4)	3.37" (85.6)	1.50" (38.1)	1.38" (34.9)
40SCF9	9/16" H/P Tube	40,000 PSI 2760 bar	1.47 in ² 948 mm ²	6.00" (152.4)	3.62" (91.9)	1.50" (38.1)	1.38" (35.1)
30SCF16	1" H/P Tube	30,000 PSI 2070 bar	1.75 in ² 1129 mm ²	6.50" (165.1)	5.55" (141.0)	2.13" (54.1)	1.75" (44.5)

*Effective area of filter element

Micron rating of filter must be specified. To order, complete the catalog number with the desired micron rating:

60SCF4-20

specifies a line filter with 1/4" H/P connections and a 20 micron filter.

All dimensions are for reference only and are subject to change.
Dimensions in parentheses are millimeters (mm)



HIGH PRESSURE SAFETY HEADS & RUPTURE DISCS

BuTech safety head assemblies serve as holders for standard rupture discs (sold separately). Safety heads with rupture discs are used as simple and inexpensive overpressure relief devices. System pressure is relieved as a result of rupture of the replaceable disc.

The safety head assemblies shown are designed for use in high pressure systems up to 60,000 PSI (4140 bar). They can be installed directly into any of our standard couplings, elbows, tees, or crosses. Their versatility also allows direct installation into a standard 3-way valve. The result is a combination valve/safety head with beneficial cost and space advantages.

Standard material of construction is 316 stainless steel.

Safety head assemblies and rupture discs are available in two styles:

The **1/4A** style features a 1/4" blow-out diameter, an angular seat and can be ordered in pressures from 900 to 60,000 PSI (62 to 4140 bar)

The **1/2F** style features a 1/2" blow-out diameter, a flat seat and can be ordered in pressures from 500 to 10,000 PSI (34 to 689 bar). This style also has a reversible hold-down ring which greatly reduces the possibility of premature disc failure associated with installation errors inherent in some designs.

Rupture discs are available in a wide range of burst ratings. Factors such as corrosion, fatigue and temperature may affect the burst pressure of the disc and cause premature failure. This problem may sometimes be overcome by frequent replacement of the disc. All discs rated over 500 PSI (34 bar) have a manufacturing tolerance of 3% under to 6% over the specified rupture pressure rating.

Rupture Discs are not included in the safety head assembly. To order discs separately, use the following part numbering system:

Style	Material	Pressure:
4=1/4" Angled	AL=Aluminum	List desired pressure at 72°F
8=1/2" Flat	IN=Inconel	(21°C) in KSI.
	MO=Monel	
	NI=Nickel	
	SI=Silver	
	SS=316SS	
	TI=Titanium	

Examples:

An Inconel disc rated for 18,000 PSI in 1/4" Angled style would be ordered as **4IN18.00**

An Aluminum disc rated for 750 PSI in 1/2" Flat style would be ordered as **8AL0.750**

SAFETY HEADS - 1/4" ANGLED DISC

Catalog Number	Connection	MAWP	A	B	C	Discharge
60SH4-1/4A	1/4" H/P Tube	60,000 PSI 4140 bar	1.00" (25.4)	2.75" (69.9)	1.00" (25.4)	3/8" FNPT
60SH6-1/4A	3/8" H/P Tube	60,000 PSI 4140 bar	1.00" (25.4)	2.81" (71.4)	1.00" (25.4)	3/8" FNPT
60SH9-1/4A	9/16" H/P Tube	60,000 PSI 4140 bar	1.38" (35.1)	2.88" (73.0)	1.00" (25.4)	3/8" FNPT
40SH9-1/4A	9/16" H/P Tube	40,000 PSI 2760 bar	1.38" (35.1)	2.88" (73.2)	1.00" (25.4)	3/8" FNPT
30SH16-1/4A	1" H/P Tube	30,000 PSI 2070 bar	1.75" (44.5)	3.38" (85.9)	1.00" (25.4)	3/8" FNPT

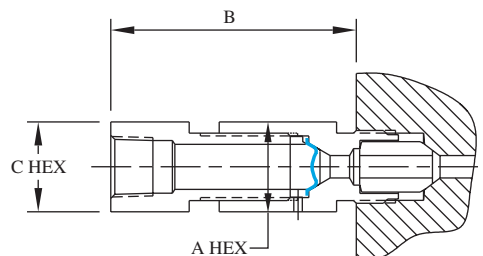

SAFETY HEADS - 1/2" FLAT DISC

Catalog Number	Connection	MAWP	A	B	C	Discharge
60SH4-1/2F	1/4" H/P Tube	10,000 PSI 689 bar	1.00" (25.4)	2.68" (68.1)	1.00" (25.4)	3/8" FNPT
60SH6-1/2F	3/8" H/P Tube	10,000 PSI 689 bar	1.00" (25.4)	2.81" (71.4)	1.00" (25.4)	3/8" FNPT
60SH9-1/2F	9/16" H/P Tube	10,000 PSI 689 bar	1.38" (35.1)	2.81" (71.4)	1.00" (25.4)	3/8" FNPT
40SH9-1/2F	9/16" H/P Tube	10,000 PSI 689 bar	1.38" (35.1)	2.81" (71.4)	1.00" (25.4)	3/8" FNPT
30SH16-1/2F	1" H/P Tube	10,000 PSI 689 bar	1.75" (44.5)	3.38" (85.9)	1.00" (25.4)	3/8" FNPT

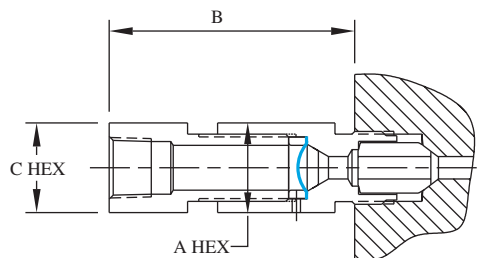

All dimensions are for reference only and are subject to change.
Dimensions in parentheses are millimeters (mm)

EQUIPMENT FOR 150,000 PSI (10,340 BAR)

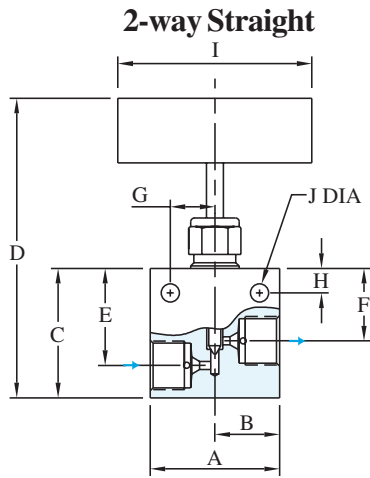

Figure 1

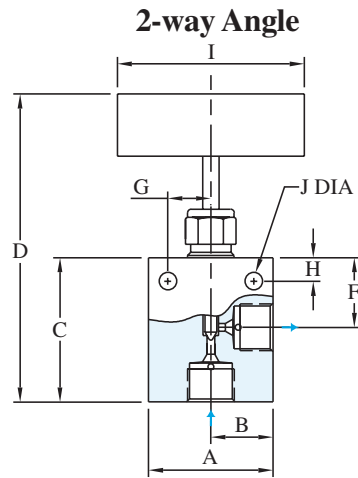

Figure 2

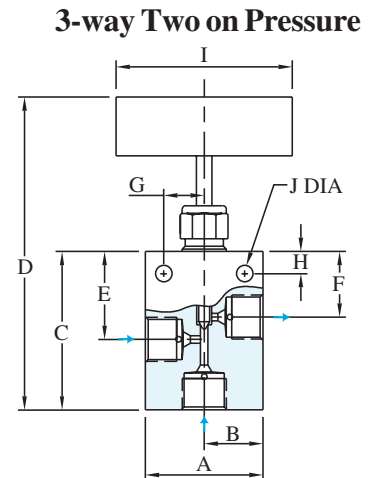
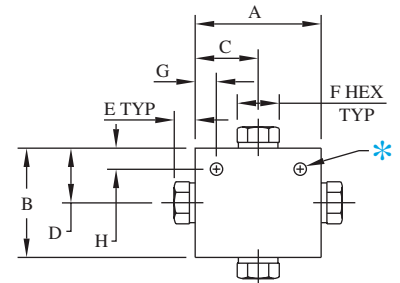
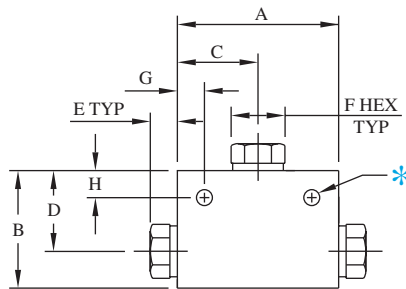
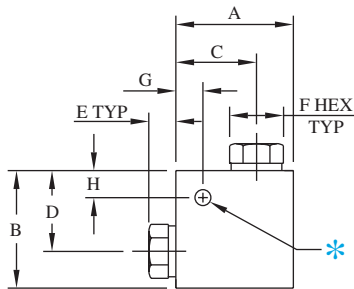

Figure 3

Catalog Number	Stem Style	Connection	Orifice	Cv	A	B	C	D	E	F	G	H	I	J	Thk.	Fig.
150V51V	Vee	5/16" H/P	0.094"	0.27	3.00"	1.50"	2.50"	5.66"	1.75"	1.44"	0.87"	0.50"	3.00"	0.34"	1.50"	1
150V51R	Reg	Tube	(2.4)		(76.2)	(38.1)	(63.5)	(143.8)	(44.5)	(36.6)	(22.1)	(12.7)	(76.2)	(8.6)	(38.1)	
150V52V	Vee	5/16" H/P	0.094"	0.40	3.00"	1.50"	2.88"	6.27"	---	1.44"	0.87"	0.50"	3.00"	0.34"	1.50"	2
150V52R	Reg	Tube	(2.4)		(76.2)	(38.1)	(73.2)	(159.3)		(36.6)	(22.1)	(12.7)	(76.2)	(8.6)	(38.1)	
150V53V	Vee	5/16" H/P	0.094"	0.40	3.00"	1.50"	3.19"	6.35"	1.75"	1.44"	0.87"	0.50"	3.00"	0.34"	1.50"	3
150V53R	Reg	Tube	(2.4)		(76.2)	(38.1)	(81.0)	(161.3)	(44.5)	(36.6)	(22.1)	(12.7)	(76.2)	(8.6)	(38.1)	



ELBOW

Catalog Number	Connection	Port	MAWP	A	B	C	D	E	F	Block Thickness	Mounting Holes*		
											G	H	Dia.
150L5	5/16" H/P Tube	0.062"	150,000 PSI 10340 bar	2.25"	2.00"	1.75"	1.38"	0.62"	0.75"	1.50"	0.50"	0.50"	0.34"
		(1.6)		(57.2)	(50.8)	(44.5)	(35.1)	(15.7)	(19.1)	(38.1)	(12.7)	(12.7)	(8.6)

TEE

Catalog Number	Connection	Port	MAWP	A	B	C	D	E	F	Block Thickness	Mounting Holes*		
											G	H	Dia.
150T5	5/16" H/P Tube	0.062"	150,000 PSI 10340 bar	3.00"	2.25"	1.50"	1.62"	0.62"	0.75"	1.50"	0.50"	0.50"	0.34"
		(1.6)		(76.2)	(57.2)	(38.1)	(41.1)	(15.7)	(19.1)	(38.1)	(12.7)	(12.7)	(8.6)

CROSS

Catalog Number	Connection	Port	MAWP	A	B	C	D	E	F	Block Thickness	Mounting Holes*		
											G	H	Dia.
150X5	5/16" H/P Tube	0.062"	150,000 PSI 10340 bar	3.00"	3.00"	1.50"	1.50"	0.62"	0.75"	1.50"	0.50"	0.50"	0.34"
		(1.6)		(76.2)	(76.2)	(38.1)	(38.1)	(15.7)	(19.1)	(38.1)	(12.7)	(12.7)	(8.6)

*Mounting holes provided when the catalog number is suffixed by "-MH" when ordering.



All dimensions are for reference only and are subject to change.
Dimensions in parentheses are millimeters (mm)



EQUIPMENT FOR 150,000 PSI (10,340 BAR)

COUPLING

Catalog							
Number	Connection	Port	MAWP	A	B	C	D
150F5	5/16" H/P Tube	0.062" (1.6)	150,000 PSI 10340 bar	1.12" (28.4)	2.62" (66.5)	0.75" (19.1)	0.62" (15.7)

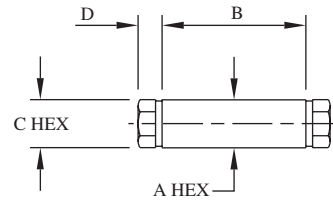

REPLACEABLE SEAT COUPLING

Catalog							
Number	Connection	Port	MAWP	A	B	C	D
150UF5	5/16" H/P Tube	0.062" (1.6)	150,000 PSI 10340 bar	1.12" (28.4)	2.62" (66.5)	0.75" (19.1)	0.62" (15.7)

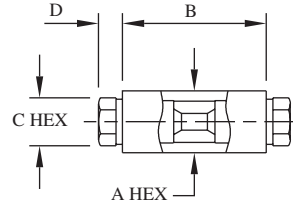

BULKHEAD

Catalog								Max Panel Thickness	Panel Hole
Number	Connection	Port	MAWP	A	B	C	D		
150BF5	5/16" H/P Tube	0.062" (1.6)	150,000 PSI 10340 bar	1.75" (44.5)	3.25" (82.6)	0.75" (19.1)	0.62" (15.7)	0.50" (12.7)	1.44" (36.6)

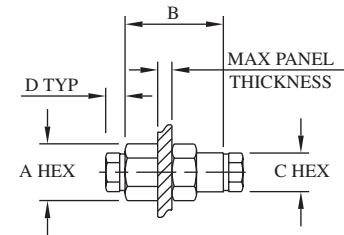

Connection Components

All BuTech valves and fittings are supplied with glands and collars. To order these components separately, use catalog numbers listed below. When using a plug, the collar is not required.



Tube Size	Collar	Gland	Plug
5/16" H/P	150C5	150G5	150P5

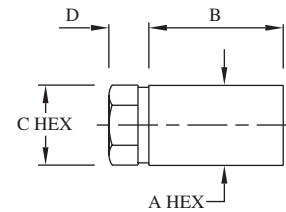

Cap	A	B	C	D
150CA5	1.12" (28.4)	1.50" (38.1)	0.75" (19.1)	0.62" (15.7)

Coned and Threaded Nipples

BuTech stocks pre-cut coned and threaded nipples in lengths up to 12" (305 mm). In addition, nipples can be purchased to any custom

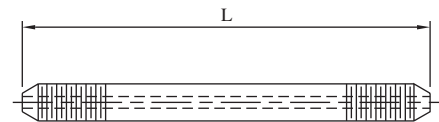

Connection	Length					MAWP
	4.00" (101.6)	6.00" (152.4)	8.00" (203.2)	10.00" (254.0)	12.00" (304.8)	
5/16" H/P	150N554-316	150N556-316	150N558-316	150N5510-316	150N5512-316	150,000 PSI 10340 bar

Tubing

Catalog				
Number	Connection	O.D.	I.D.	MAWP
150-063-316	5/16" H/P	0.312" (7.9)	0.063" (1.6)	150,000 PSI 10340 bar

BuTech offers a complete selection of austenitic seamless cold-drawn stainless steel tubing for high pressure applications where both high strength and corrosion resistance are desired. Tubing is available in standard 20-24 foot lengths (6-7 meters), however, longer lengths are available on request.

All dimensions are for reference only and are subject to change.
Dimensions in parentheses are millimeters (mm)